

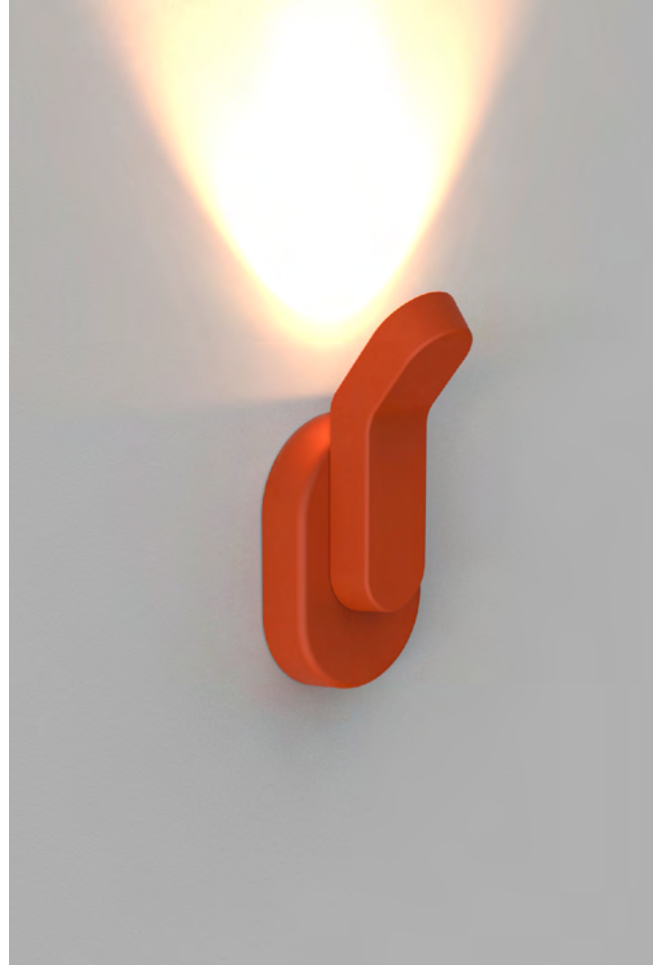

SALUS

Power failures can happen for a variety of reasons, such as weather disasters or defects in power lines. To avoid panic in the dark, light helps. Therefore the idea was to create a wall lamp that can also be used as a flash light. The lamp is characterized by its angle, which makes it possible to illuminate its surroundings. Laid on its back or placed sideways, you can adapt the light source to your personal use. The lamp recharges itself on the wall module and has an autonomy of 17 hours when disconnected from the power supply. It also has two light levels; by pressing the button, you can choose between atmospheric light, strong torch light or the switch-off function.

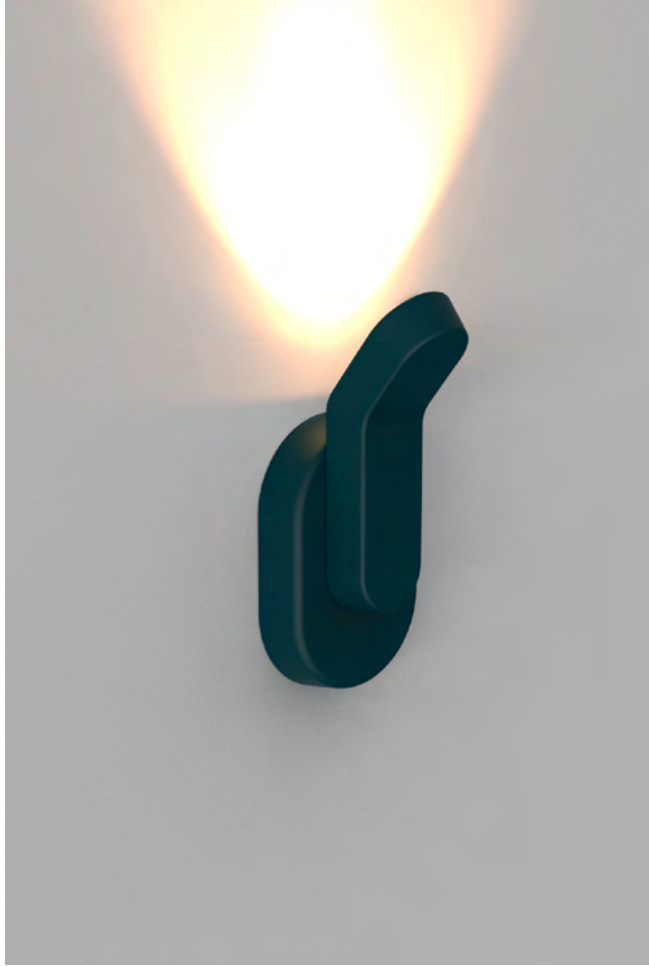







Power failures



Reference

Form research

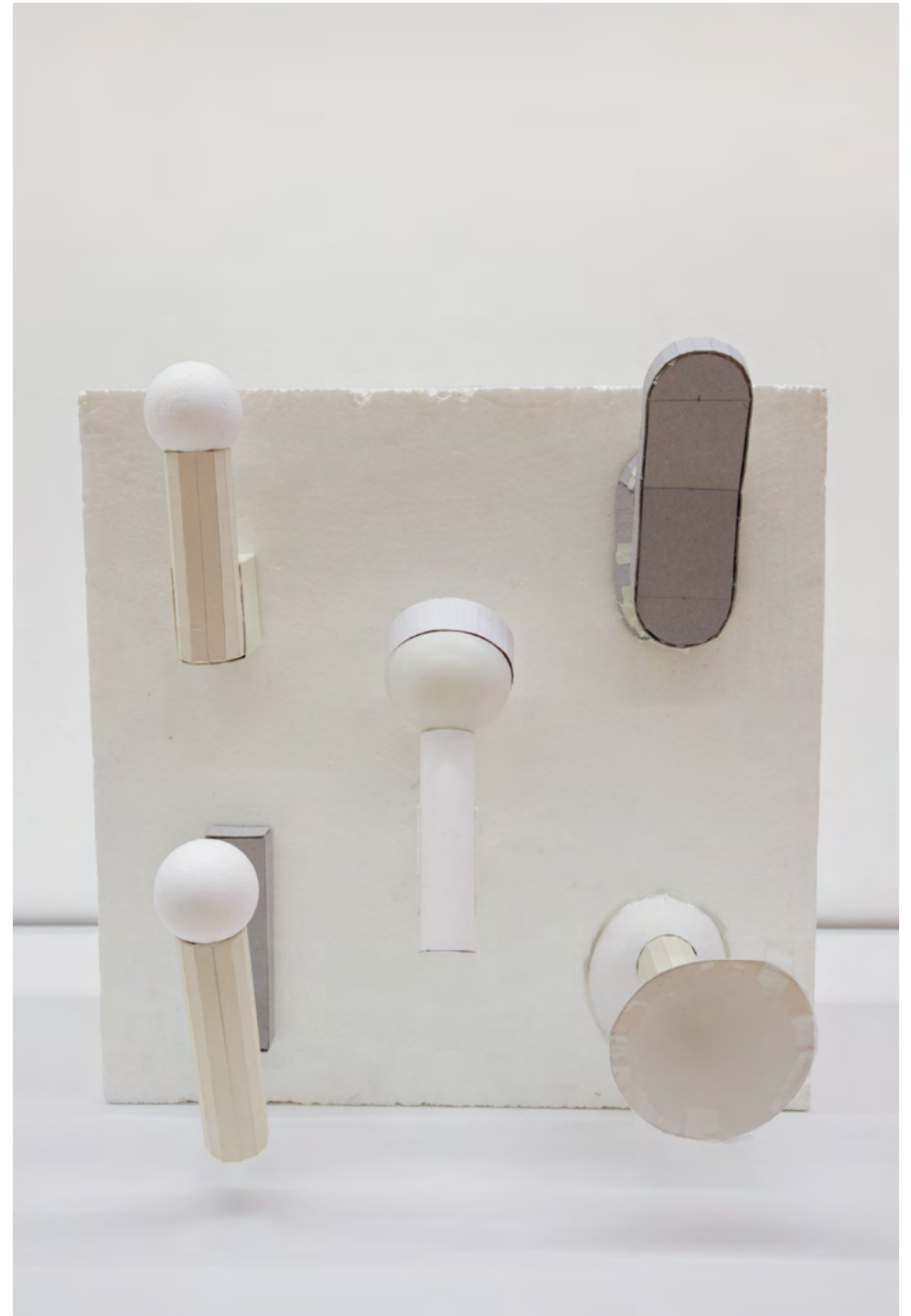

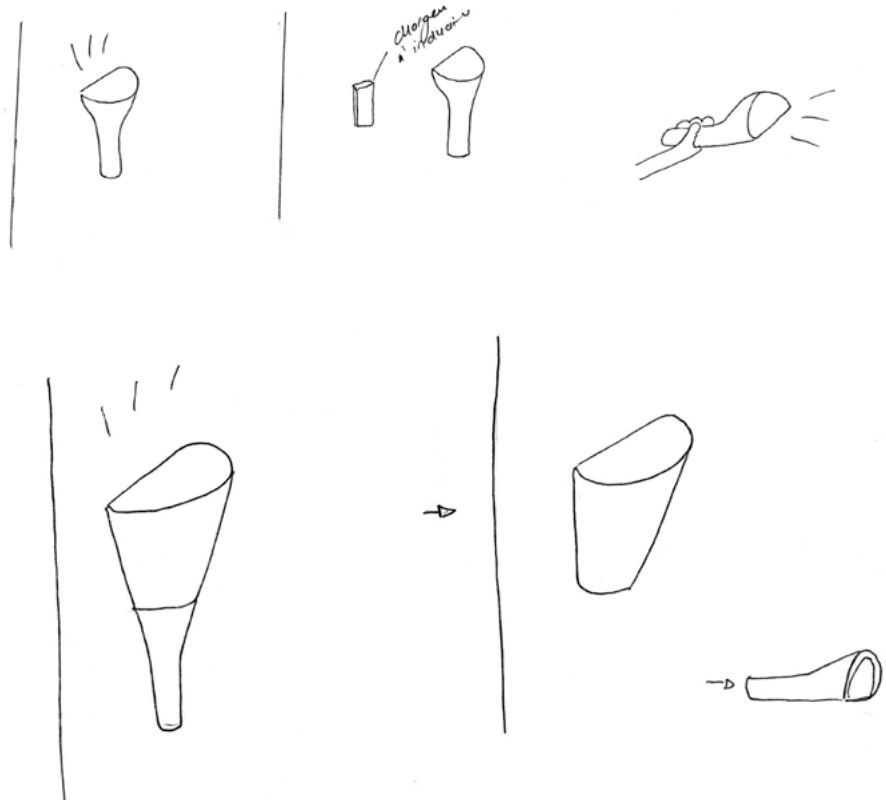

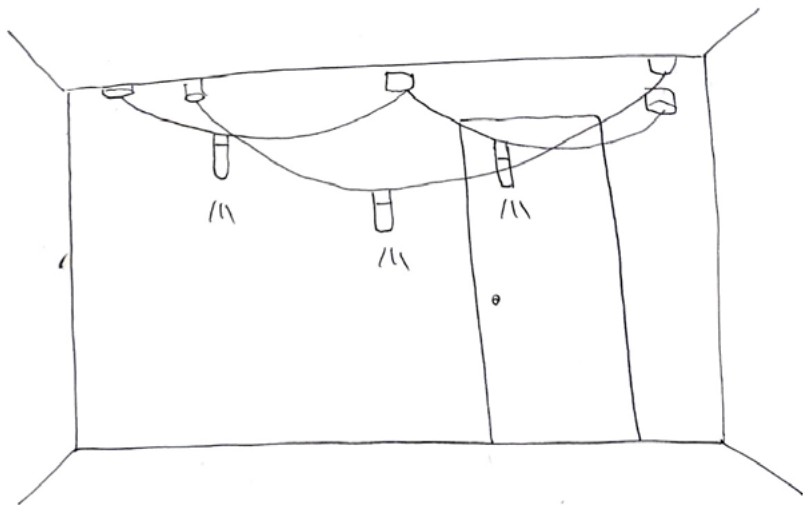
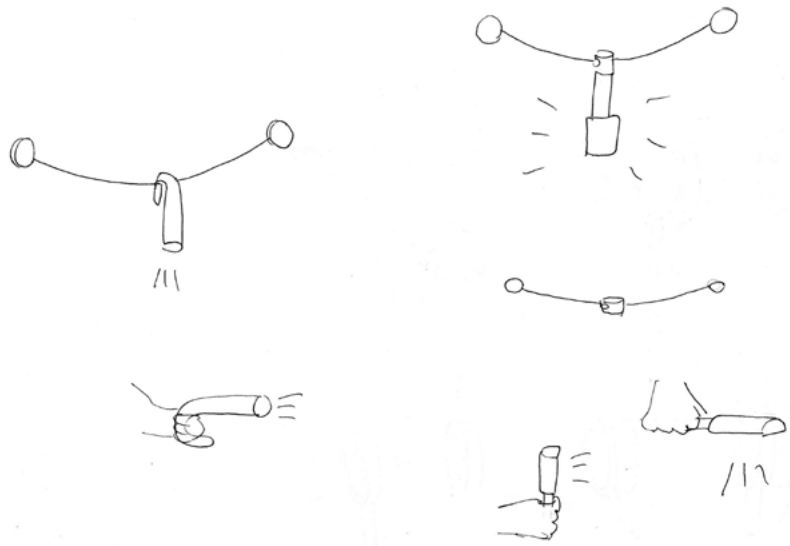

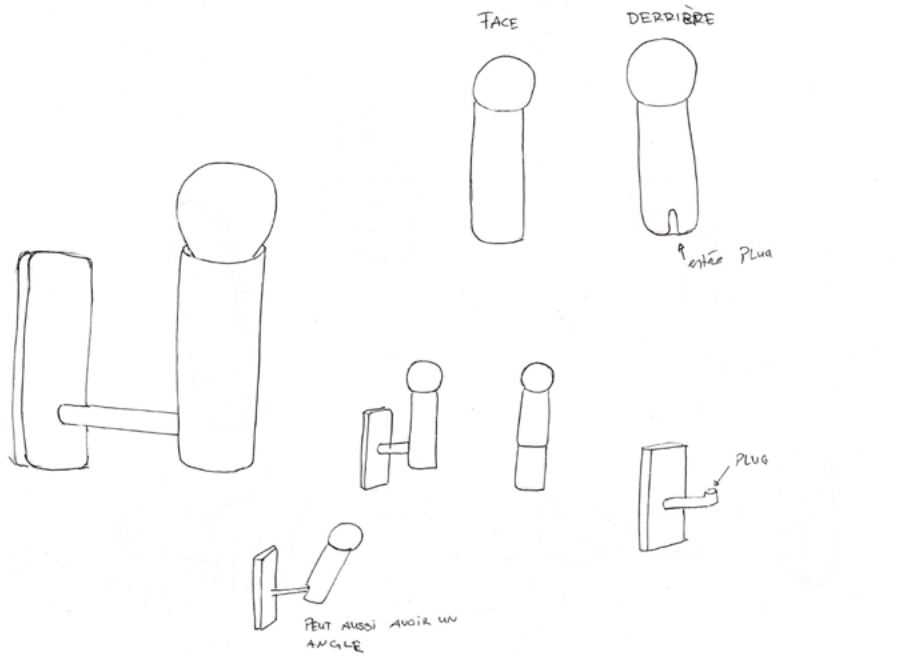
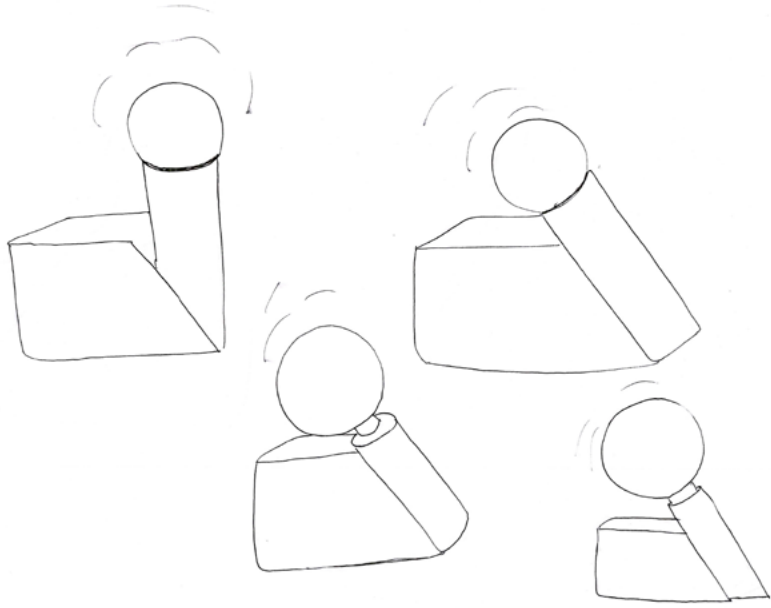

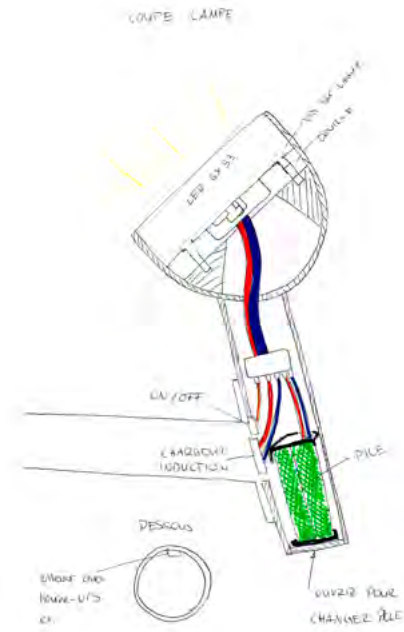

COUPE
SUPPORT

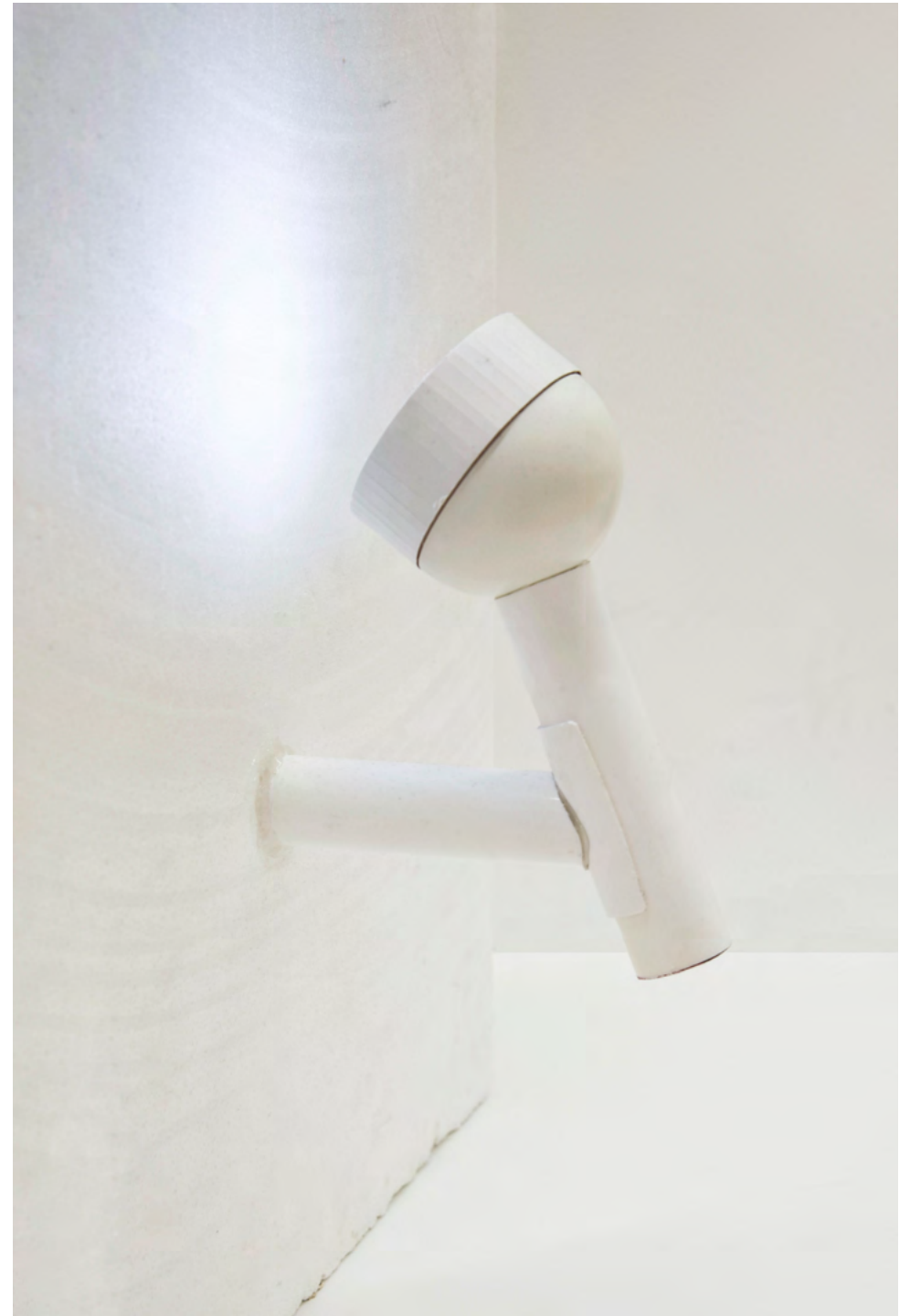
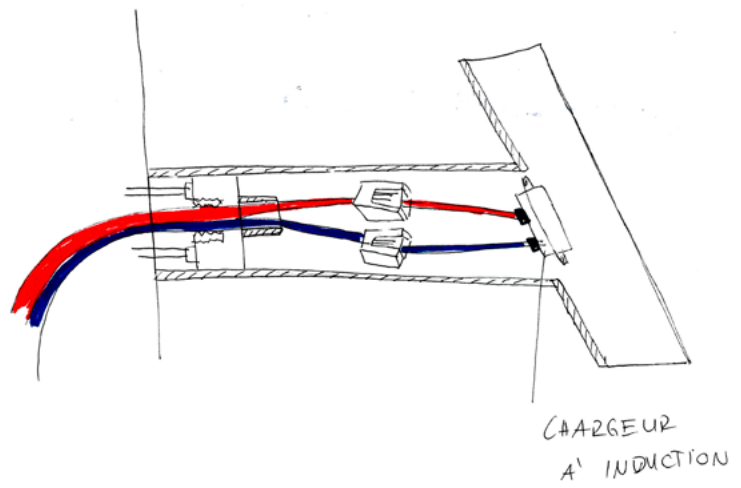

FIYATION AU MUR

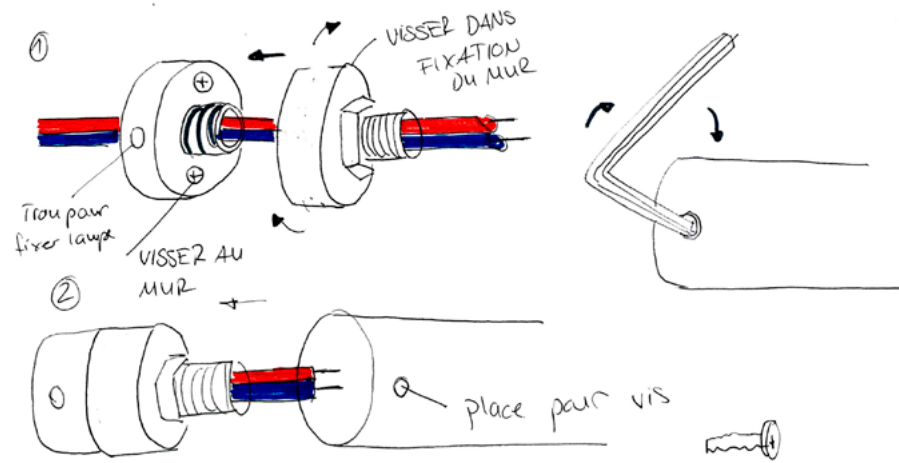

OU ALORS

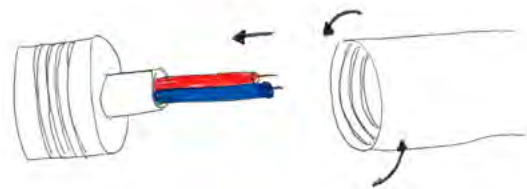
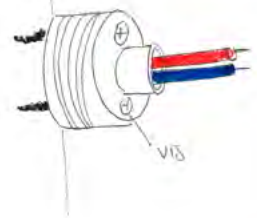

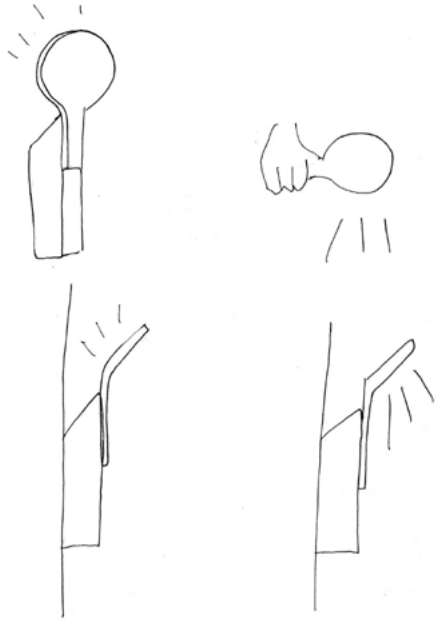

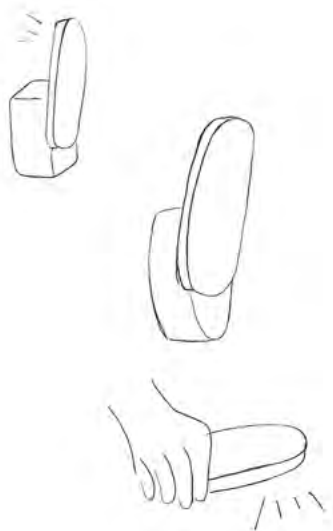
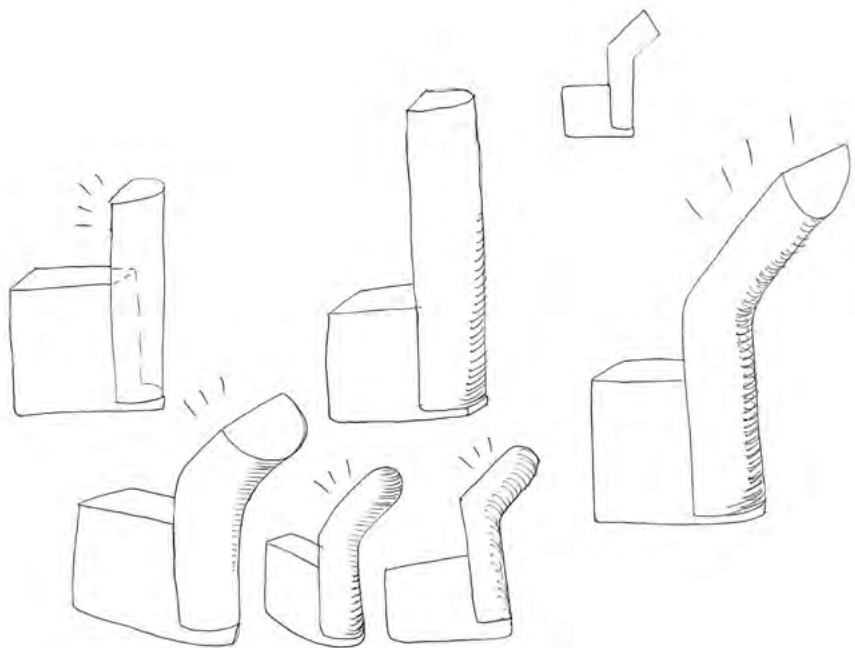



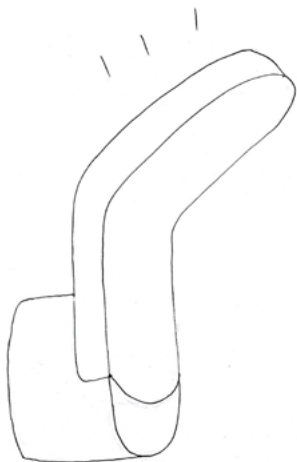
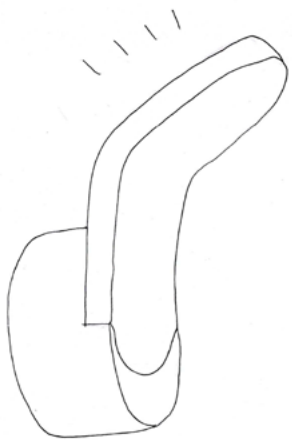



②

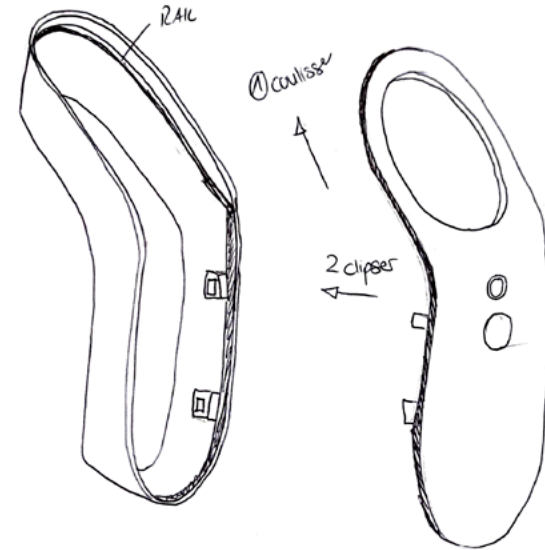
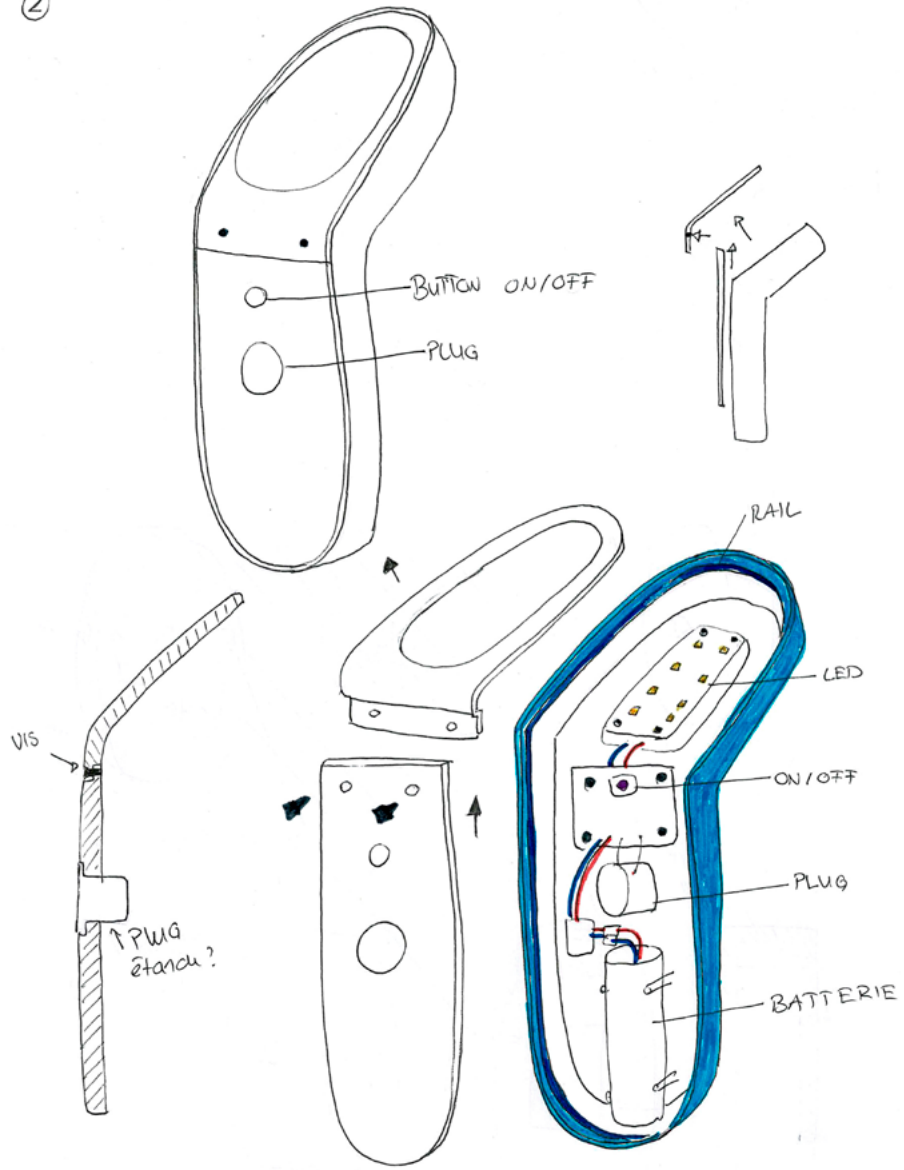

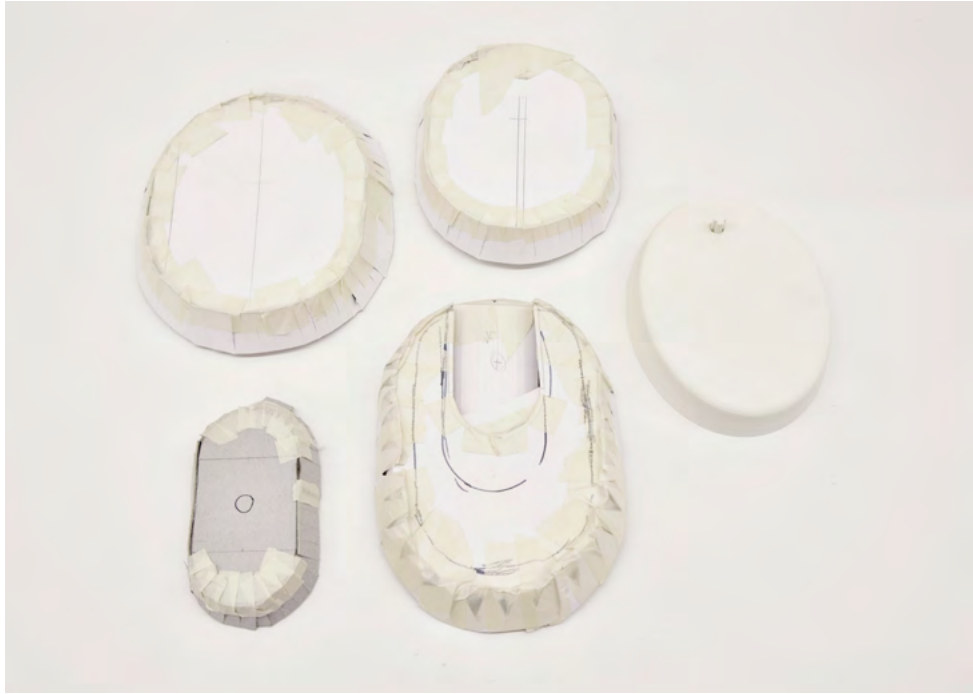

- Atmospheric light, 2700 K, less dense
- Light of the flash light, 5000K, more dense
- Holes for screws

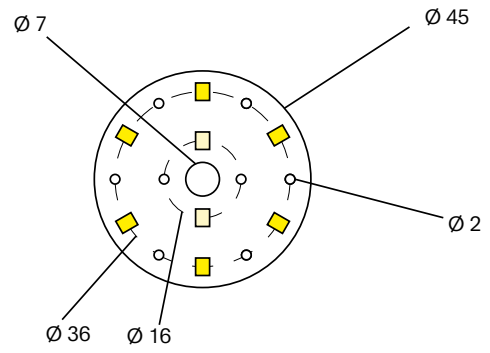

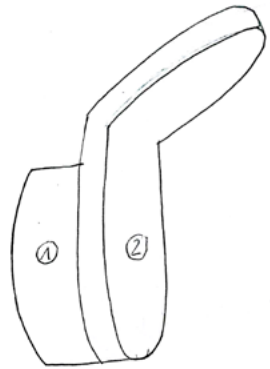

①

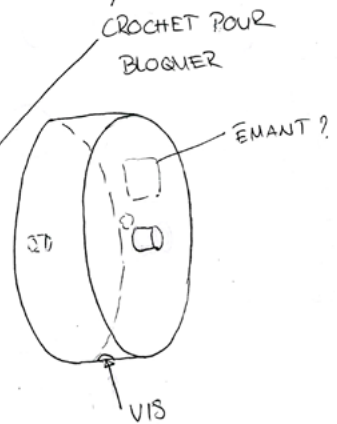
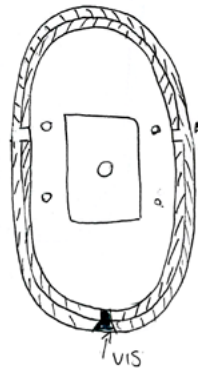
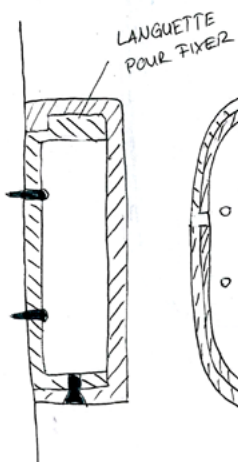
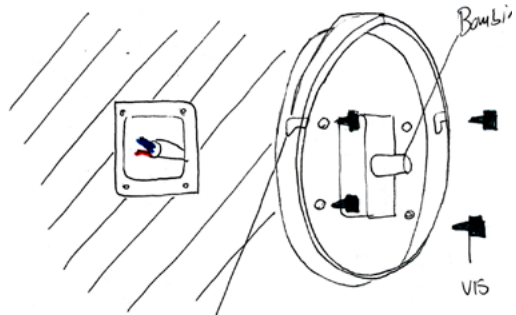
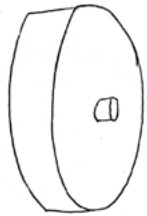

Hanging system

WALL

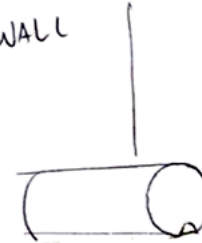

RAIL de
COULISSEMENT

LAMPE



WALL

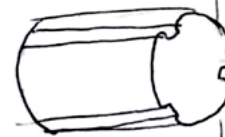

LAMPE



Clip system for fixing the lamp to the wall module

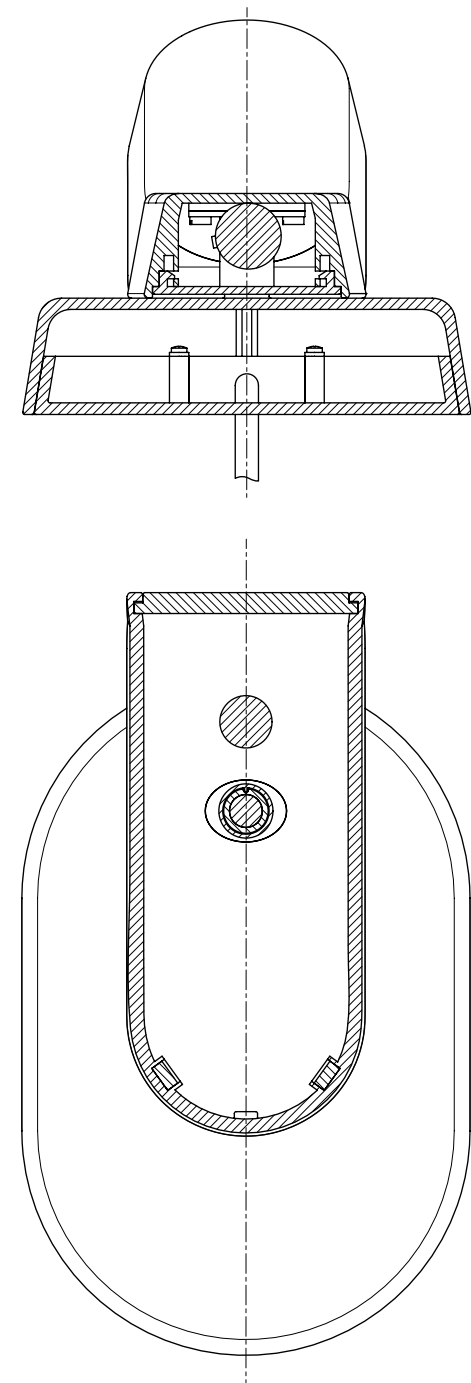
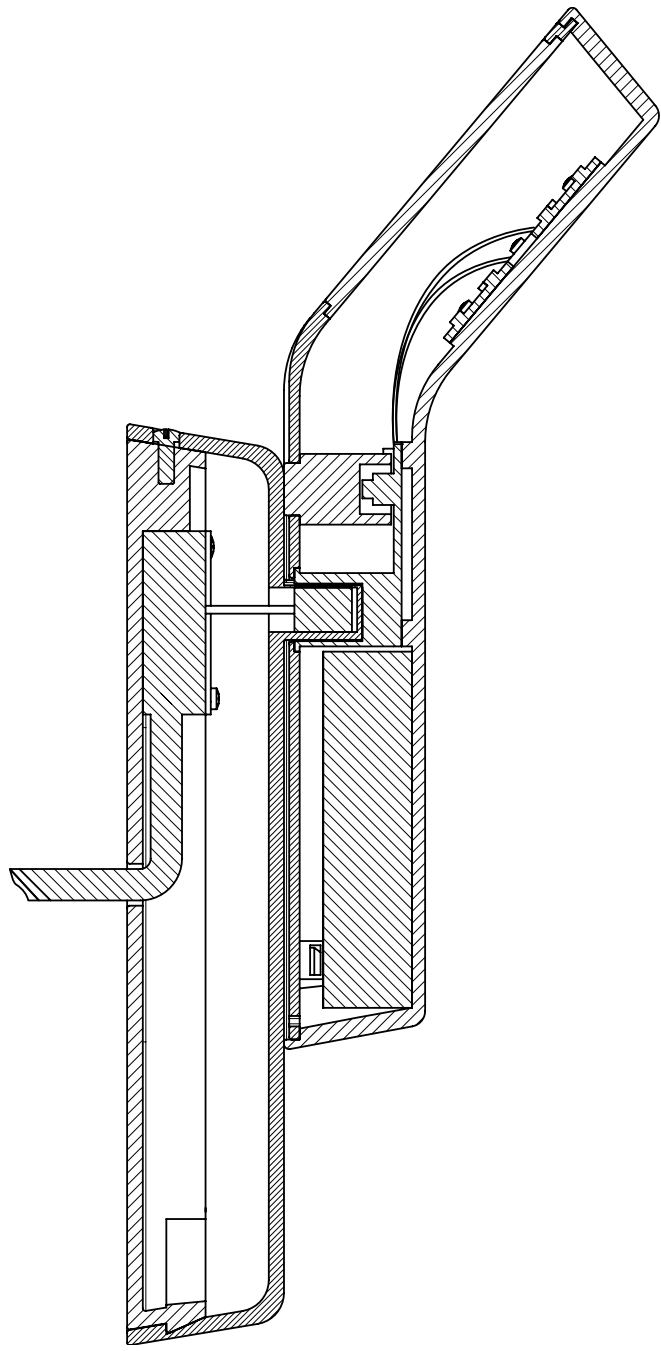

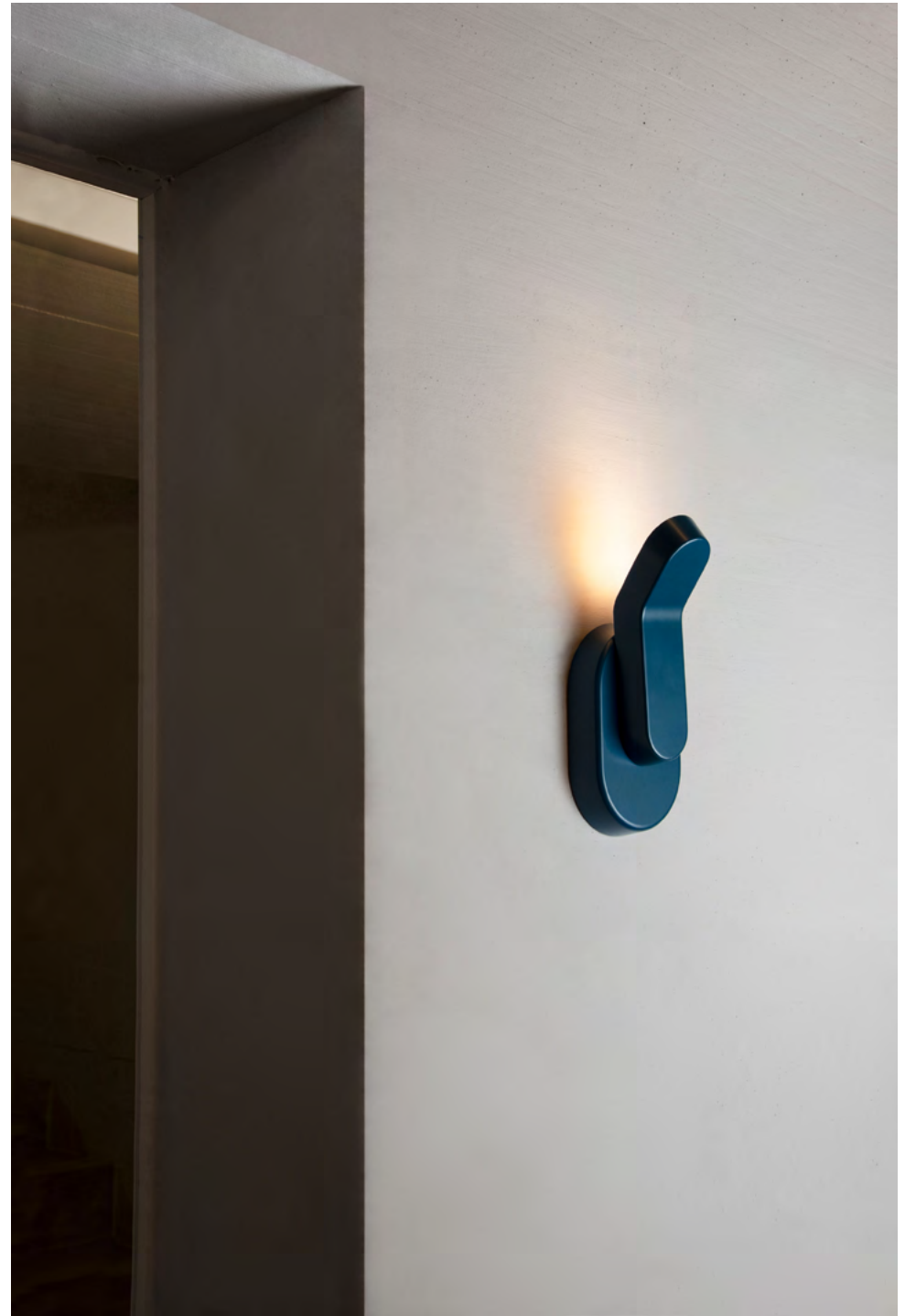



Lucie Herter
Wall light
Salus