



bügal.

designed by Bence Ridder and Calvin Middel



WHAT - BÜGAL is the symbiosis of a clothing hanger and a shelf, embodied in an intelligent design. The multifunctional furniture allows hanging clothes and at the same time provides storage for smaller everyday items.

WHY- BÜGAL wants to be a furniture piece that combines useful functions with the purpose of having a positive impact on users everyday life. Also it can be seen as an aesthetic and unique looking piece of furniture.

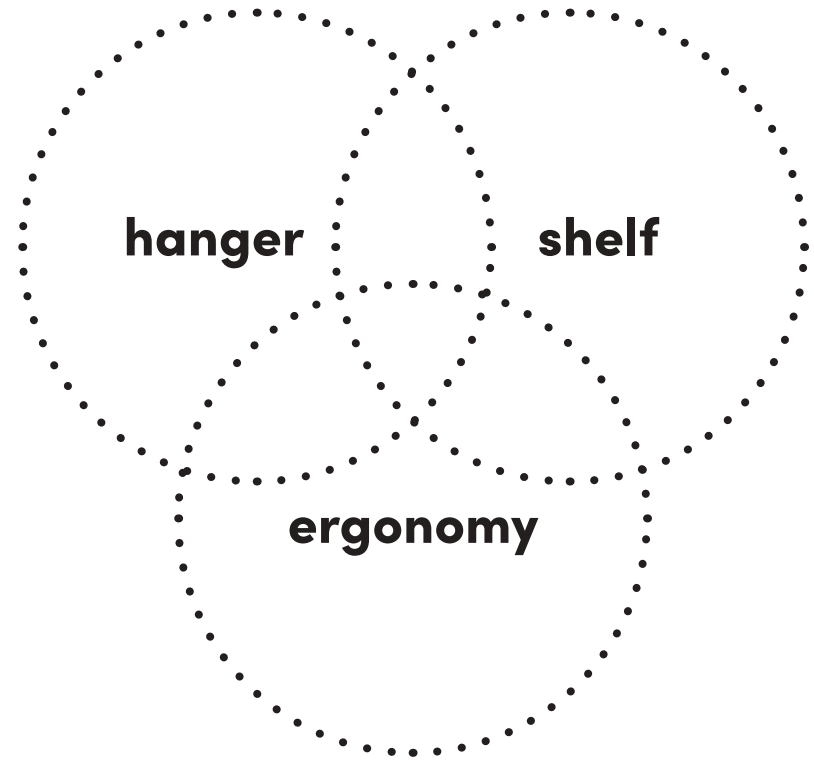

process.

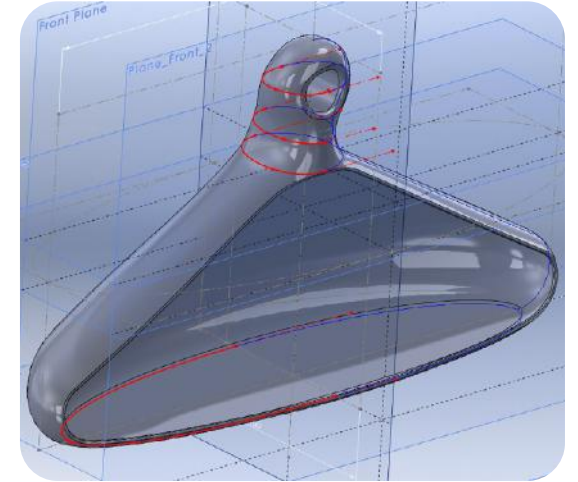
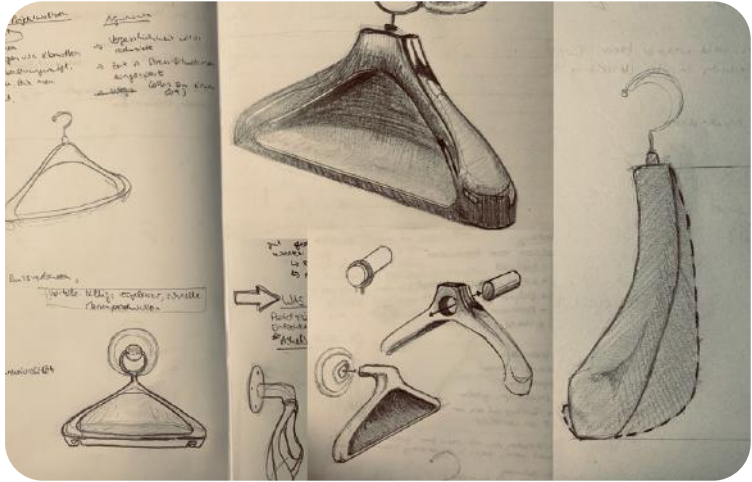

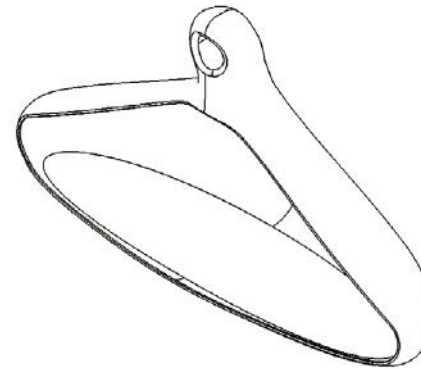
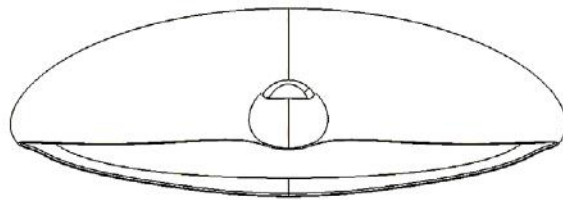
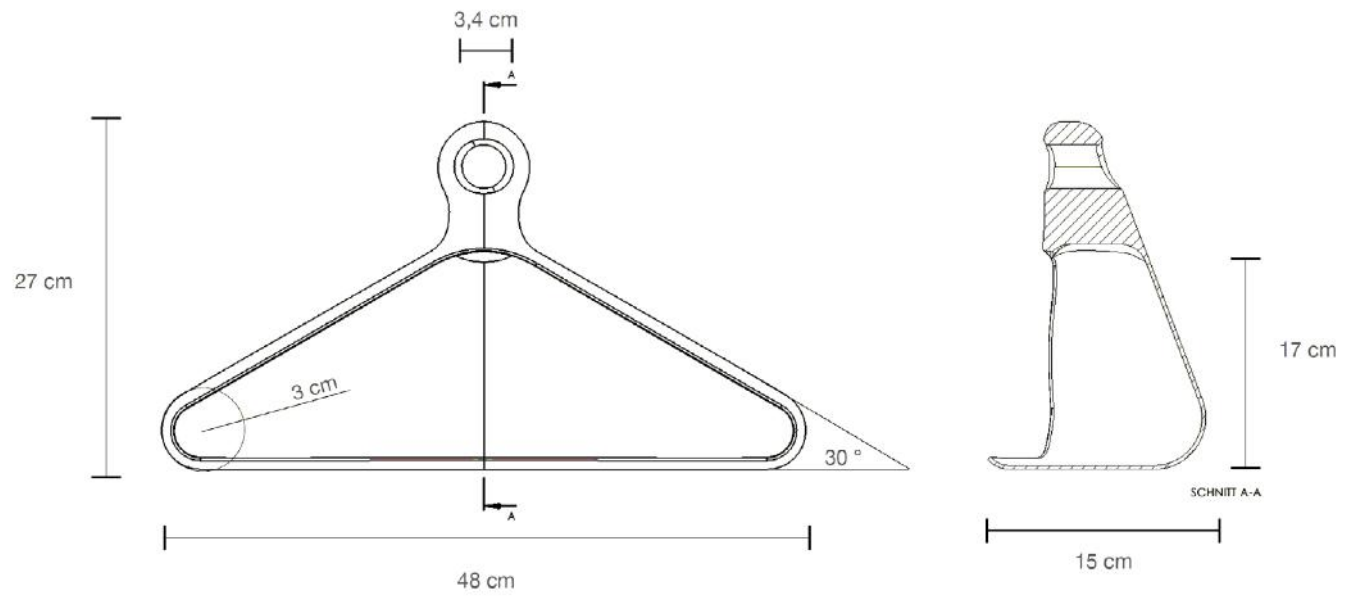

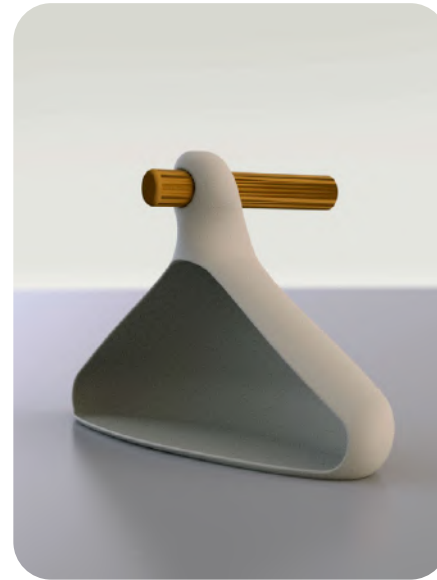
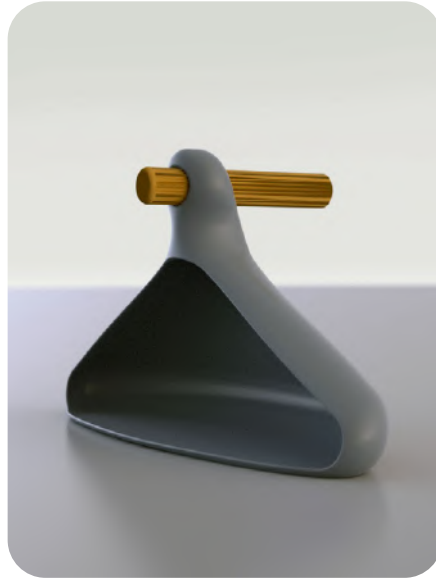
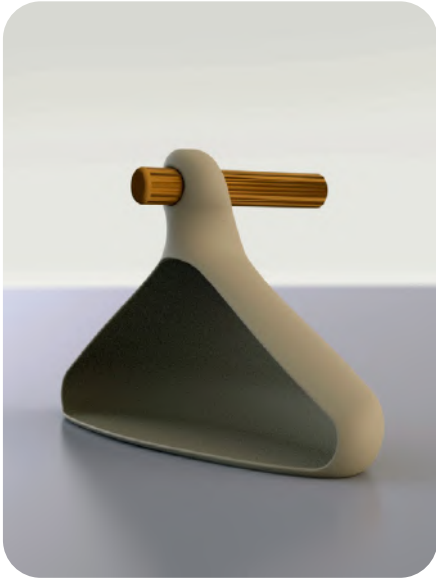



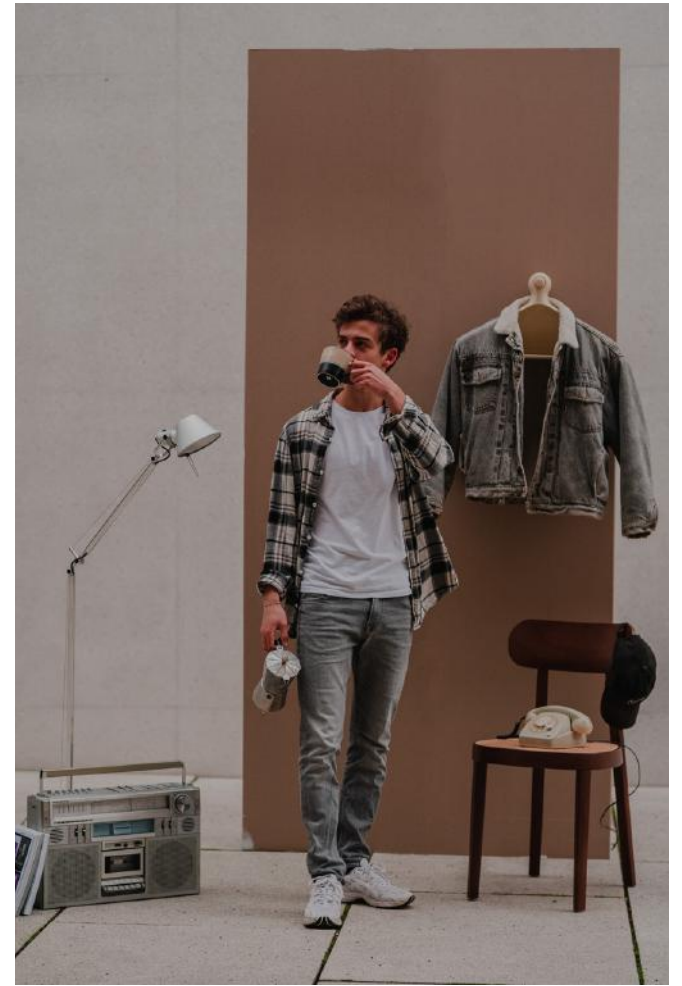

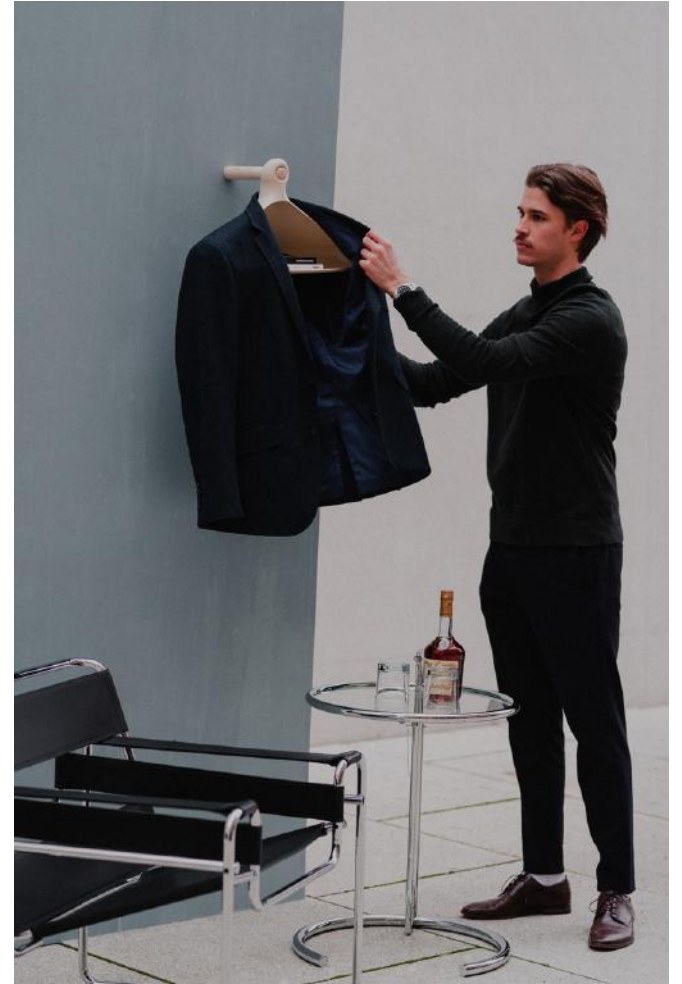

contact.

Bence Ridder
Stuttstraße 64
48149 Münster
GERMANY
Tel +49 (0)151 633 52 63
benceridder@gmail.com

Calvin Middel
Hubertstraße 19
48155 Münster
GERMANY
Tel +49 (0)157 578 22 83 9
middel.calvin@gmail.com

